



LUNA

BATHROOM, KITCHEN & LAUNDRY COLLECTION





Caroma Classic is our most popular and affordable range of products. Loved by Australians for its proven reputation of high-quality construction, durability and longevity, these designs have become classics in homes across the country.

The Classic collection brings everyday luxury experiences through classic styles and functional design for people seeking DIY and good value products. So, you can create the sanctuary of your dreams, without compromise.

“With an extensive range of quality products and a choice of colour finishes, the **Luna** collection is the practical choice to create your sanctuary.”



A handwritten signature in black ink that reads 'LDM'.

- Luke Di Michiel,
Caroma Industrial Designer



LUNA

The Luna Collection offers reliable and durable products that are well-designed with Australian ingenuity to suit your lifestyle. The extensive product range suits almost any bathroom, kitchen or laundry and are practical for an everyday luxury experience.

Featuring a range of colour finishes across tapware, showers and accessories, the Luna collection can be tailored to your personal style.

LUNA COLOUR RANGE







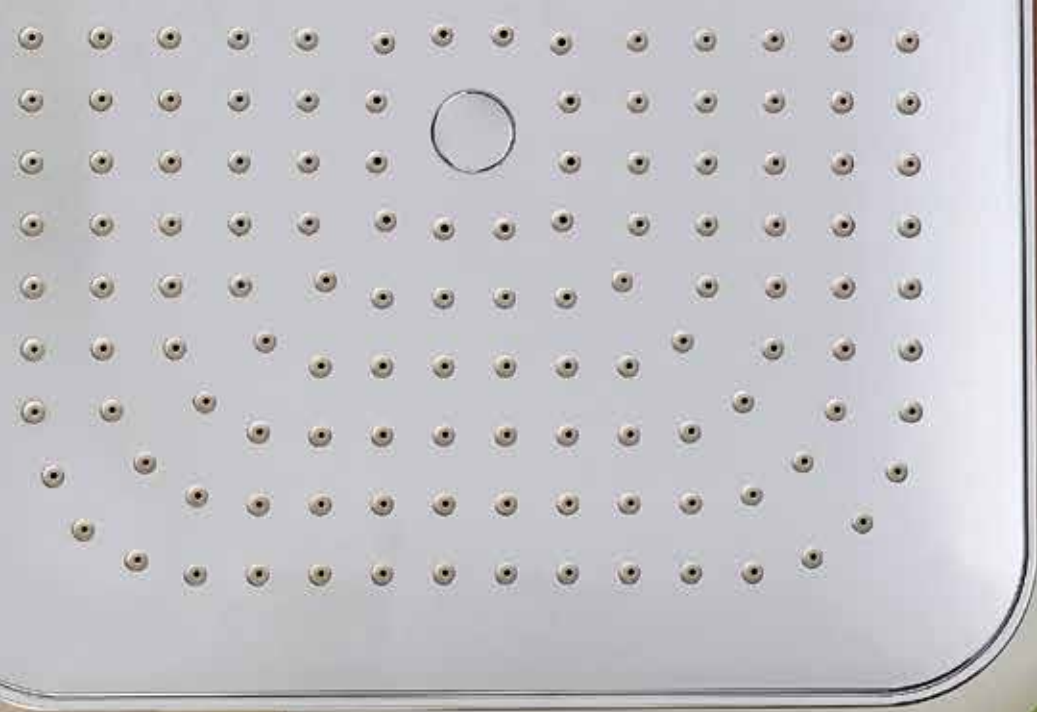



Create your *sanctuary*



①
Luna Back to Wall
Bath 1400
LU4WFW

⑦
Luna Metal Shelf
99610BL



②
Luna Overhead
Shower System
On Rail
90383BL4E

④
Luna Semi
Recessed Basin
(Without Tap
Landing)
873500W



⑧
Luna Bath/
Shower Mixer
68184BL



Pop up Plug and Waste
687329BL

⑨
Luna Hand
Towel Rail
99611BL



③
Luna
Cleanflush®
Wall Faced
Toilet Suite
844810W



⑤
Luna Single Towel
Rail 630mm
99612BL



⑩
Luna Toilet
Roll Holder
99607BL



⑥
Luna Wall Basin/
Bath Mixer
68186BL6A



BZL/BTN Round 'SM/FL'
415028BL

8

5



2

7

3

1

8

6

9

4

5

Create your *sanctuary*

10



1

Luna Tower Basin Mixer
68183BB6A



3

Luna Above Counter Basin (Without Tap Landing)
899000W



6

Luna Double Towel Rail
930mm
99615BB



7

Luna Hand Towel Rail
99611BB



8

Luna Metal Shelf
99610BB



2

Luna Cleanflush® Wall Faced Toilet Suite
844810W



Pop up Plug and Waste
687329BB

4

Luna Right Angle Shower Arm
90390BB



5

Luna Overhead Shower Head Only
90386BB4E



9

Luna Toilet Roll Holder
99607BB



10

Luna Shower Mixer
68184BB



BZL/BTN Round 'SM/FL'
415028BB



9

4

6

3

2

8

7

10

1

11

Create your *sanctuary*



①
Luna Back to Wall
Bath 1400
LU4WFW



⑦
Luna Metal
Shelf
99610BN



②
Luna Multi
Function
Rail Shower
90384BN4F



④
Luna Semi
Recessed Basin
873615W

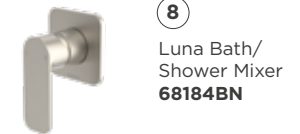

⑧
Luna Bath/
Shower Mixer
68184BN



Pop up Plug and Waste
687329BN



⑨
Luna Basin
Mixer
68181BN6A



③
Luna
Cleanflush®
Wall Faced
Toilet Suite
844810W



⑤
Luna Double Towel
Rail 930mm
99615BN



⑩
Luna Wall
Basin/Bath
Mixer
68186BN6A



BZL/BTN Round 'SM/FL'
415028BN



⑥
Luna Hand
Towel Rail
99611BN



⑪
Luna Toilet
Roll Holder
99607BN



10

8

4

5

1

3

2

6

Create your *sanctuary*



①
Luna Four Tile
Flange Bath 1675
LU7W



②
Luna Lever
Bath Tap Set
90331C

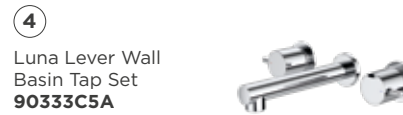

④
Luna Lever Wall
Basin Tap Set
90333C5A



③
Luna Multi
Function Rail
Shower
90384C4F



⑤
Luna Semi
Recessed Basin
(Without Tap
Landing)
873500W



⑥
Luna Single Towel Rail 630mm
99612C



⑦
Luna Cleanflush®
Close Coupled S
Trap Back Entry
Toilet Suite
844730W



⑧
Luna Hand
Towel Rail
99611C



⑨
Luna Toilet
Roll Holder
99607C



⑩
Luna Robe
Hook
99608C

7

9







SEMI RECESSED BASIN



INSET BASIN

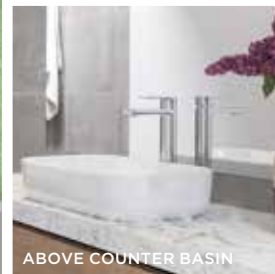

ABOVE COUNTER BASIN



WALL BASIN

Basins

Luna basins are curved and classic in their design, making them a stylish choice for your bathroom that will stand the test of time.

With many style and size options available, you'll be spoiled for choice when selecting basins for a small ensuite through to a large family bathroom.



ABOVE COUNTER BASIN

Above counter basins are installed directly on top of a vanity with minimal installation requirements.

INSET BASIN

Inset basins are partially set into a vanity reducing the appearance of the basin rim without reducing the depth of the bowl.

SEMI RECESSED BASIN

Semi recessed basins partially overhang the vanity allowing you to maximise your basin size on applications with limited vanity space.

WALL BASIN

Wall basins are installed directly to the wall with no need for an additional vanity.



Caroma wall basins are tested to withstand excess load up to 150kg **5x industry standard**

EN 14688 : 2015 Sanitary appliances - wash basins - functional requirements and test methods.

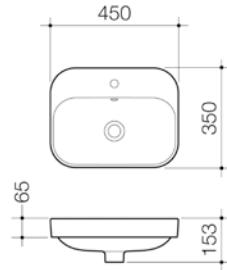

Luna Inset Vanity Basin

0 taphole 899205W
 1 taphole 899215W
 3 taphole 899235W

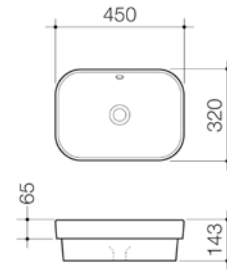

**Luna Inset Vanity Basin
(Without Tap Landing)**

0 taphole 899105W

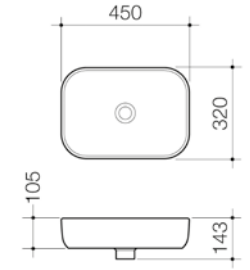

Luna Above Counter Basin

0 taphole 899000W

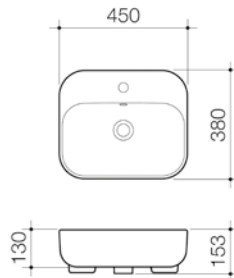

Luna Semi Recessed Basin

0 taphole 873605W
 1 taphole 873615W

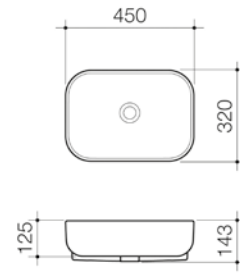

**Luna Semi Recessed Basin
(Without Tap Landing)**

0 taphole 873500W

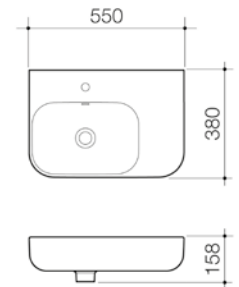

Luna Shelf Wall Basin

0 taphole 873905W
 1 taphole 873915W
 3 taphole 873935W

Right hand shelf
 and left hand shelf
 available

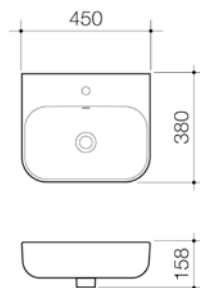

Luna Wall Basin

0 taphole 874205W
 1 taphole 874215W
 3 taphole 874235W

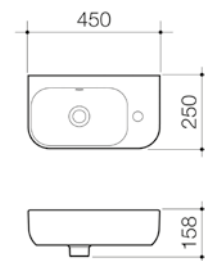

Luna Hand Wall Basin

1 taphole 873715W

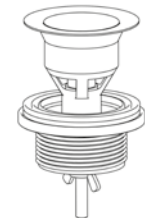

Pop-up Plug and Waste

687329C 687329BN
 687329BL 687329BB

Showers

A sleek, modern shower will not only enhance the appearance of any bathroom but also your daily bathing experience.

Our Luna range of eco-friendly showers are engineered with a superior water saving rating, without any compromise on performance.



FIXED SHOWER

A fixed arm with a pivoting head either from the wall or ceiling for a clean stylish look.

HAND SHOWER

Provides added functionality to a fixed wall option with the ability to remove the handpiece.

SHOWERS ON RAILS

Convenient, adjustable height rail for ultimate control.



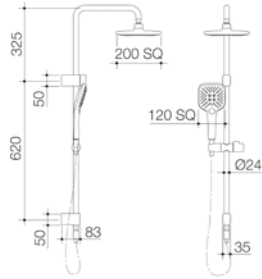

Luna Overhead Shower System On Rail

Hand Shower: WELS 5 star rated, 6L/min
Overhead: WELS 4 star rated, 7.5L/min

- 90383C4E ● 90383BN4E
- 90383BL4E ● 90383BB4E

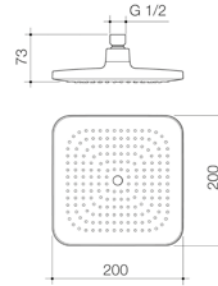

Luna Overhead Shower Head Only

WELS 4 star rated, 6-7.5L/min

- 90386C4E ● 90386BN4E
- 90386BL4E ● 90386BB4E

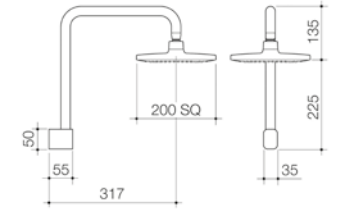

Luna Fixed Overhead Shower

WELS 4 star rated, 6-7.5L/min

- 90391C4E ● 90391BN4E
- 90391BL4E ● 90391BB4E

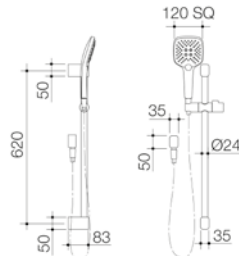

Luna Multi Function Rail Shower

WELS 5 star rated, 6L/min

- 90384C4F ● 90384BN4F
- 90384BL4F ● 90384BB4F

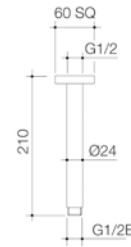

Luna Ceiling Shower Arm 210mm

- 90388C ● 90388BN
- 90388BL ● 90388BB

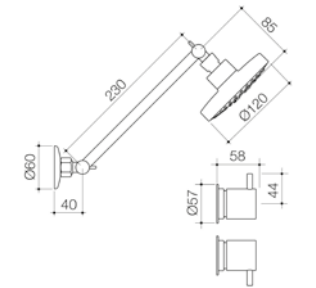

Luna Lever Shower Set

WELS 3 star rated, 7.5-9L/min

- 90332C3A ● 90332BL3A

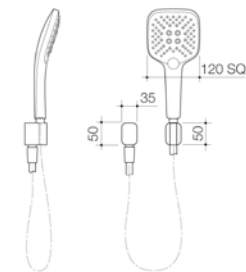

Luna Multi Function Hand Shower

WELS 5 star rated, 6L/min

- 90385C4F ● 90385BN4F
- 90385BL4F ● 90385BB4F

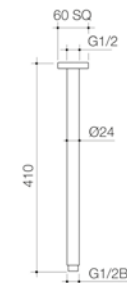

Luna Ceiling Shower Arm 410mm

- 90389C ● 90389BN
- 90389BL ● 90389BB



Luna Right Angle Shower Arm

Right angle

- 90390C ● 90390BN
- 90390BL ● 90390BB

Baths

Our range of Luna baths feature soft lines for a modern, minimalistic look. The gentle recline allows you to lie back and relax in style.

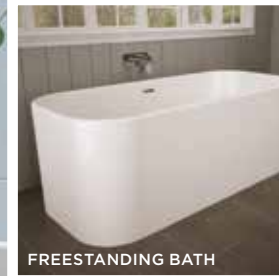

FREESTANDING BATH

FREESTANDING BATH

The Luna freestanding bath is only 1400mm in length, meaning that even small bathrooms can have this luxurious style of bath.

BACK TO WALL FREESTANDING BATH

The Luna back to wall bath combines the luxury of a freestanding bath with the practicalities of an island bath. Sitting flush to the wall means it is not only easy to clean but opens up the choice of tapware to wall bath mixers.

ISLAND BATHS

Island baths are recessed into a constructed frame which is usually finished using tiles or stone leaving only the small raised rim of the bath visible. The island bath offers extra room around the bath, perfect for candles, a sitting ledge, or the kids' toys.

FOUR TILE FLANGE BATHS

This style is necessary for a bath that will also be used as a shower. It works to redirect the shower spray run-off directly back into the bath without the moisture damaging the walls.

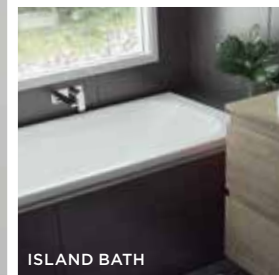

ISLAND BATH

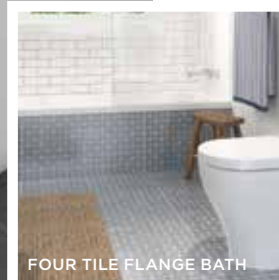

FOUR TILE FLANGE BATH

BACK TO WALL FREESTANDING BATH

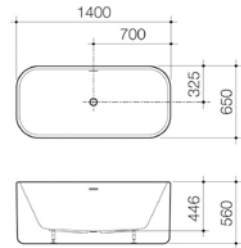

Luna Freestanding Bath

1400

LU4FSW

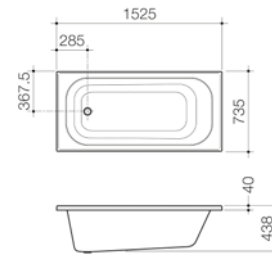

Luna Four Tile Flange Bath

1525

LU5W

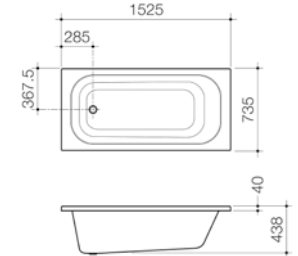

Luna Island Bath

1525

LU5ISW

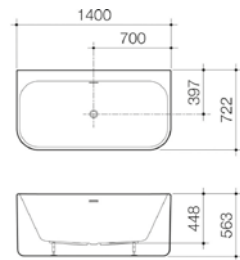

Luna Back to Wall Bath

1400

LU4WFW

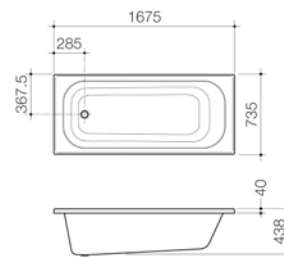

Luna Four Tile Flange Bath

1675

LU7W

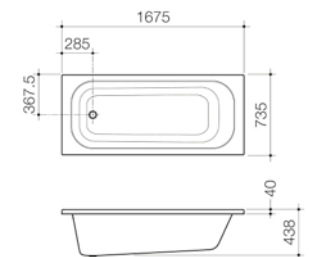

Luna Island Bath

1675

LU7ISW

Tapware

Updating your tapware is a quick and easy way to modernise your bathroom. The Luna tapware range has been designed to be retrofitted to existing bathrooms or be the perfect stylish addition to any new bathroom. The curved shape makes for easy cleaning and care.





Luna Lever Basin Tap Set

WELS 5 star rated, 4.5-6L/min

● 90334C5A ● 90334BL5A



Luna Lever Basin Handle Set

Basin mount

● 90335C ● 90335BL



Luna Lever Washing Machine Tap Set

● 90336C ● 90336BL

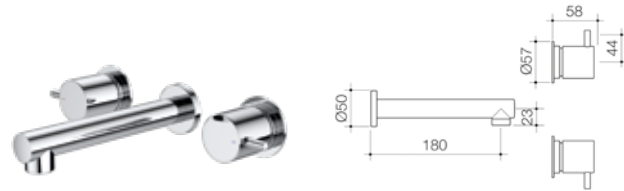

Luna Lever Wall Basin Tap Set

WELS 5 star rated, 4.5-6L/min

● 90333C5A ● 90333BL5A

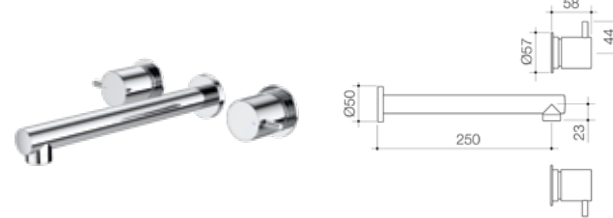

Luna Lever Bath Tap Set

● 90331C ● 90331BL

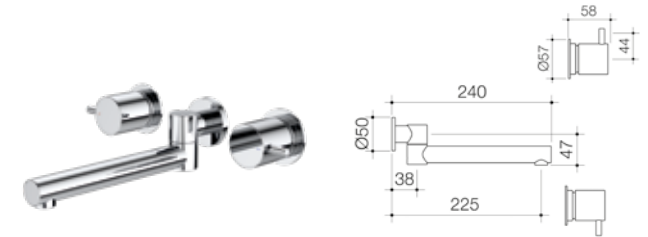

Luna Lever Laundry Tap Set

WELS 4 star rated, 6-7.5L/min

● 90331C4A ● 90331BL4A



Luna Lever Basin Outlet 185mm

WELS 5 star rated, 4.5-6L/min

● 90335C5A

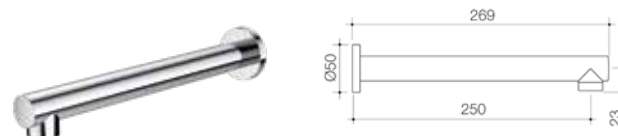

Luna Lever Bath Outlet 250mm

● 90337C



Luna Lever Wall Handle Set

Wall mount

● 90332C ● 90332BL



Mixers

The subtle curves of the Luna mixer range bring a modern but timeless feel to your bathroom.

20
YEAR*
WARRANTY



HIGH
QUALITY



SMOOTH HANDLE
OPERATION

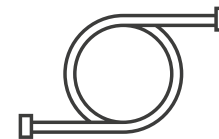

SUPERIOR
HOSES



LEAK PROOF

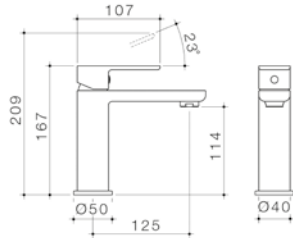

Luna Standard Basin Mixer

WELS 6 star rated, 4.5L/min

- 68181C6A ● 68181BN6A
- 68181BL6A ● 68181BB6A

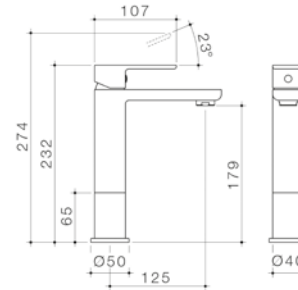

Luna Mid Basin Mixer

WELS 6 star rated, 4.5L/min

- 68182C6A ● 68182BL6A

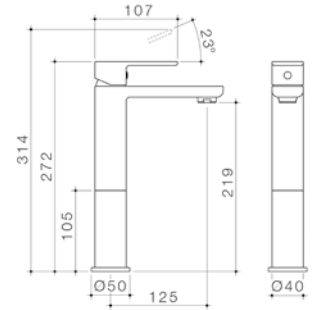

Luna Tower Basin Mixer

WELS 6 star rated, 4.5L/min

- 68183C6A ● 68183BN6A
- 68183BL6A ● 68183BB6A

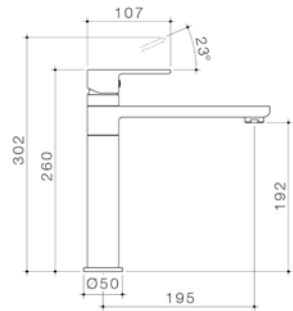

Luna Sink Mixer

WELS 4 star rated, 7.5L/min

- 68188C4A

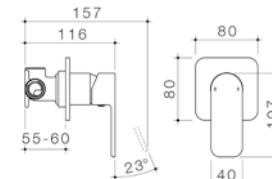

Luna Bath/Shower Mixer

Without Diverter

- 68184C ● 68184BN
- 68184BL ● 68184BB

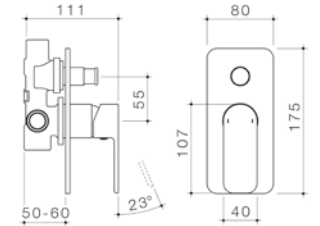

Luna Bath/Shower Mixer With Diverter

With Diverter

- 68185C ● 68185BN
- 68185BL ● 68185BB

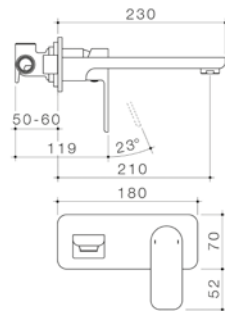

Luna Wall Basin/Bath Mixer

WELS 6 star rated, 4.5L/min

- 68186C6A ● 68186BN6A
- 68186BL6A ● 68186BB6A

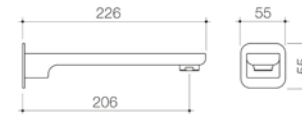

Luna Wall Basin/Bath Outlet

WELS 6 star rated, 4.5L/min

- 68187C6A ● 68187BN6A
- 68187BL6A ● 68187BB6A

Toilet suites

Our Luna range of toilet suites feature Caroma patented Cleanflush® technology. Caroma Cleanflush® is our most effective and hygienic toilet. Our patented design features revolutionary rimless technology that delivers the next generation of toilets: easy to clean and water efficient with superior hygiene.

20
YEAR*
WARRANTY

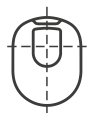

EASY CLEAN
DROP ZONE



SUPERIOR RIMLESS
HYGIENE



UNI-ORBITAL CONNECTOR
FLEXIBLE INSTALLATION



LOAD TESTED

INVISI WALL FACED TOILET SUITES (BEHIND THE WALL / CONCEALED)

The toilet pan sits on the floor and is connected to a cistern concealed inside the wall cavity, ceiling or under counter.

WALL FACED TOILET SUITE (OR BACK TO WALL)

The toilet pan sits flush to the wall with the cistern mounted directly on top.

CLOSE COUPLE TOILET SUITE

The toilet pan sits on the floor with the cistern mounted directly on top, leaving a small gap between the pan and the wall.



FLOW SPLITTER
Powerful flush for whole
bowl clean



FLOW CHANNELS
Controlled water flow
eliminates splash back



FLOW BALANCER
Precise flush stream
effectively clears the bowl





Luna Cleanflush® Wall Faced Toilet Suite

WELS 4 star rated, 4.5/3L (3.5L avg/flush)

Bottom Inlet* 844810W
Back Entry* 844820W

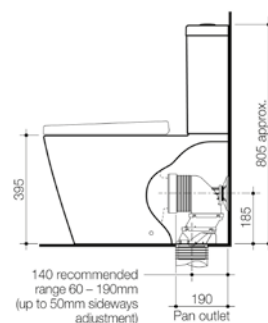

Luna Square Cleanflush® Wall Faced Toilet Suite

WELS 4 star rated, 4.5/3L (3.5L avg/flush)

Bottom Inlet* 846410W
Back Entry* 846420W

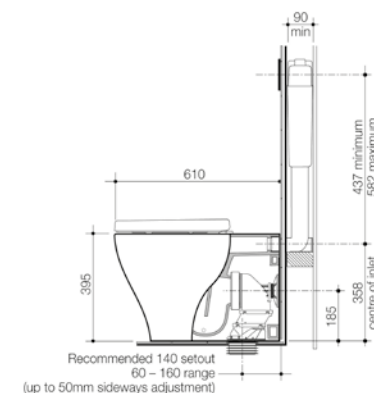

Luna Cleanflush® Wall Faced Invisi Series II® Toilet Suite

WELS 4 star rated, 4.5/3L (3.5L avg/flush)

Back Entry* 844910W

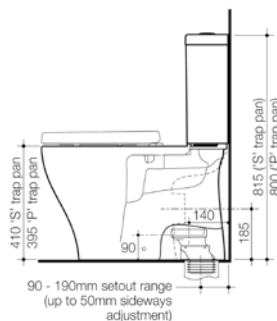

Luna Cleanflush® Close Coupled P Trap Toilet Suite

WELS 4 star rated, 4.5/3L (3.5L avg/flush)

P Trap Bottom Inlet* 844720W
P Trap Back Entry* 844740W

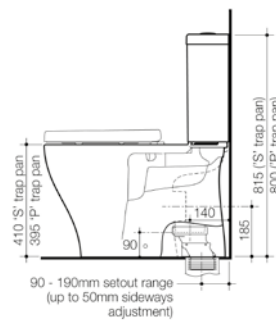

Luna Cleanflush® Close Coupled S Trap Toilet Suite

WELS 4 star rated, 4.5/3L (3.5L avg/flush)

S Trap Bottom Inlet* 844710W
S Trap Back Entry* 844730W

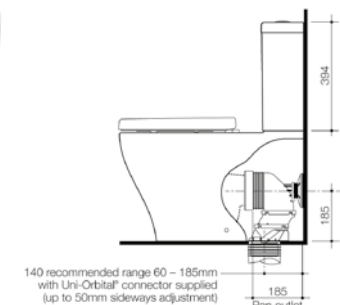

Luna Wall Faced Toilet Suite

WELS 4 star rated, 4.5/3L (3.5L avg/flush)

Bottom Inlet* 829710W
Back Entry* 829720W

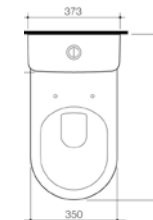

*Bottom Inlet - for installation flexibility
*Back Entry - for a concealed connection



Accessories

Our Luna range of accessories bring the finishing touch to your bathroom. The range of towel rails, hooks, shelves and toilet roll holders will complement the rest of your choices from the Luna collection.



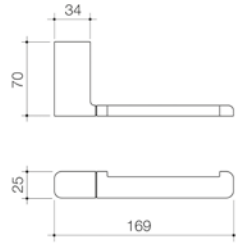

Luna Toilet Roll Holder

- 99607C 99607BN
- 99607BL 99607BB

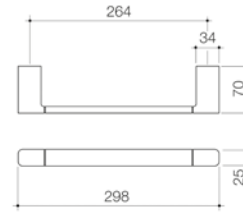

Luna Hand Towel Rail

- 99611C 99611BN
- 99611BL 99611BB

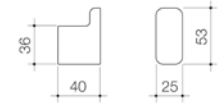

Luna Robe Hook

- 99608C 99608BN
- 99608BL 99608BB

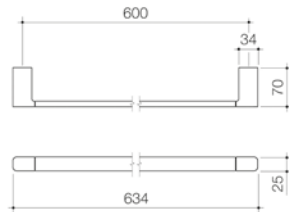

Luna Single Towel Rail 630mm

- 99612C 99612BL

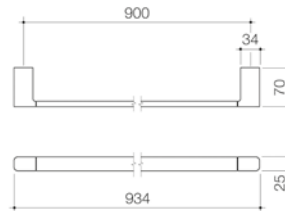

Luna Single Towel Rail 930mm

- 99613C 99613BL

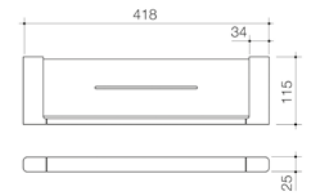

Luna Metal Shelf

- 99610C 99610BN
- 99610BL 99610BB

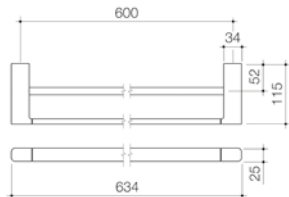

Luna Double Towel Rail 630mm

- 99614C 99614BN
- 99614BL 99614BB

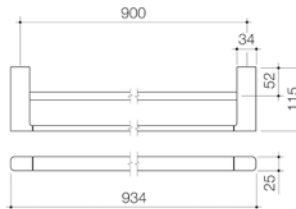

Luna Double Towel Rail 930mm

- 99615C 99615BN
- 99615BL 99615BB

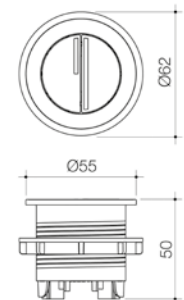

Bzl/Btn Round 'Sm/FI'

- 415028C 415028BN
- 415028BL 415028BB

Sinks & Tubs

Luna sinks and tubs are made from premium materials for maximum durability and hygiene. The generous bowl sizes with matching accessories provide additional functionality.



STEEL
304 GRADE



INCLUDES STEEL
BASKET WASTE



EASY TO
CLEAN



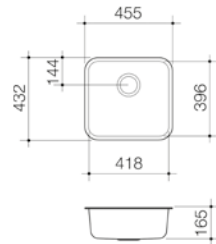

Luna Single Bowl
COCL100

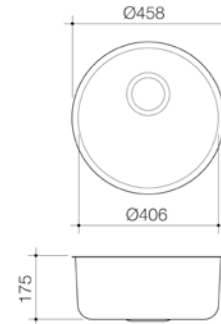

Luna Round Bowl
COCL300

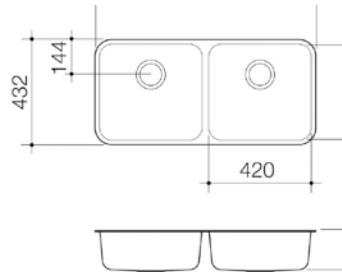

Luna Double Bowl
COCL200

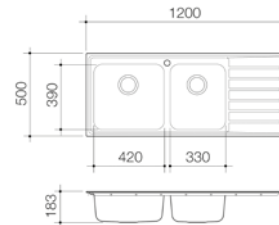

**Luna 1.75 End Bowl
- Left Hand Configuration**
COCL175.1L

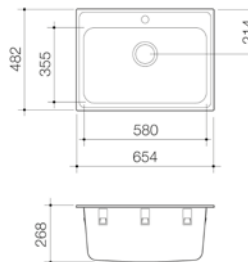

Luna 45L Laundry Tub
COCL45.1

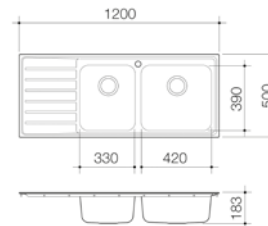

**Luna 1.75 End Bowl
- Right Hand Configuration**
COCL175.1R

OPTIONAL ACCESSORIES

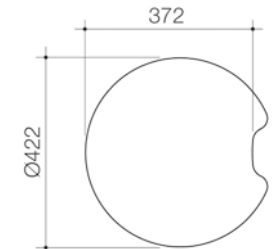

Luna Round Chopping Board
COCLAC030

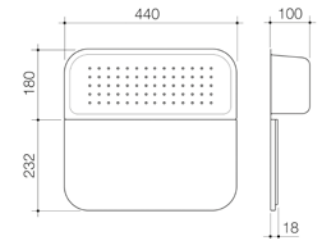

Luna Board & Colander Set
COCLAC020

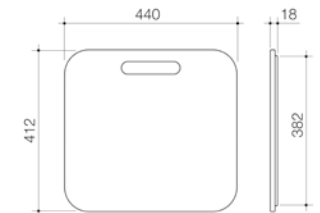

Luna Chopping Board
COCLAC010

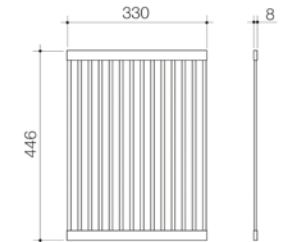

Luna Roll Out Drying Mat
COCLAC040







With over 78 years of experience, we believe quality bathrooms are a balance of form, function and looks. Our designs and innovation bring to life a guiding vision of creating sustainable luxury. Design that enables you to enjoy bathroom experiences that both complement and elevate your lifestyle, from an energising morning start to an indulgent, relaxing moment of luxury, all underpinned by sustainability.

Designing for Australians and New Zealanders, from all walks of life, with different tastes and needs; we have a wide range of classic to artisanal styles, smart designs and sustainable innovations providing you with everything you need to create the *sanctuary of your dreams.*

www.caroma.com.au | www.caroma.co.nz

© Copyright 2020. Caroma Industries Ltd. ABN 35 000 189 499. All rights reserved. Material and design specifications subject to change without notice. Product colour reproduction is as near to actual product colour as production methods allow. Warning: Products in this brochure are the subject of registered designs and patents. * is a registered trademark of Caroma Industries. This brochure relates to Australian products only and some product, design or specifications may differ in other countries.